

# FUNDAMENTALS OF SPECTRUM ANALYSIS

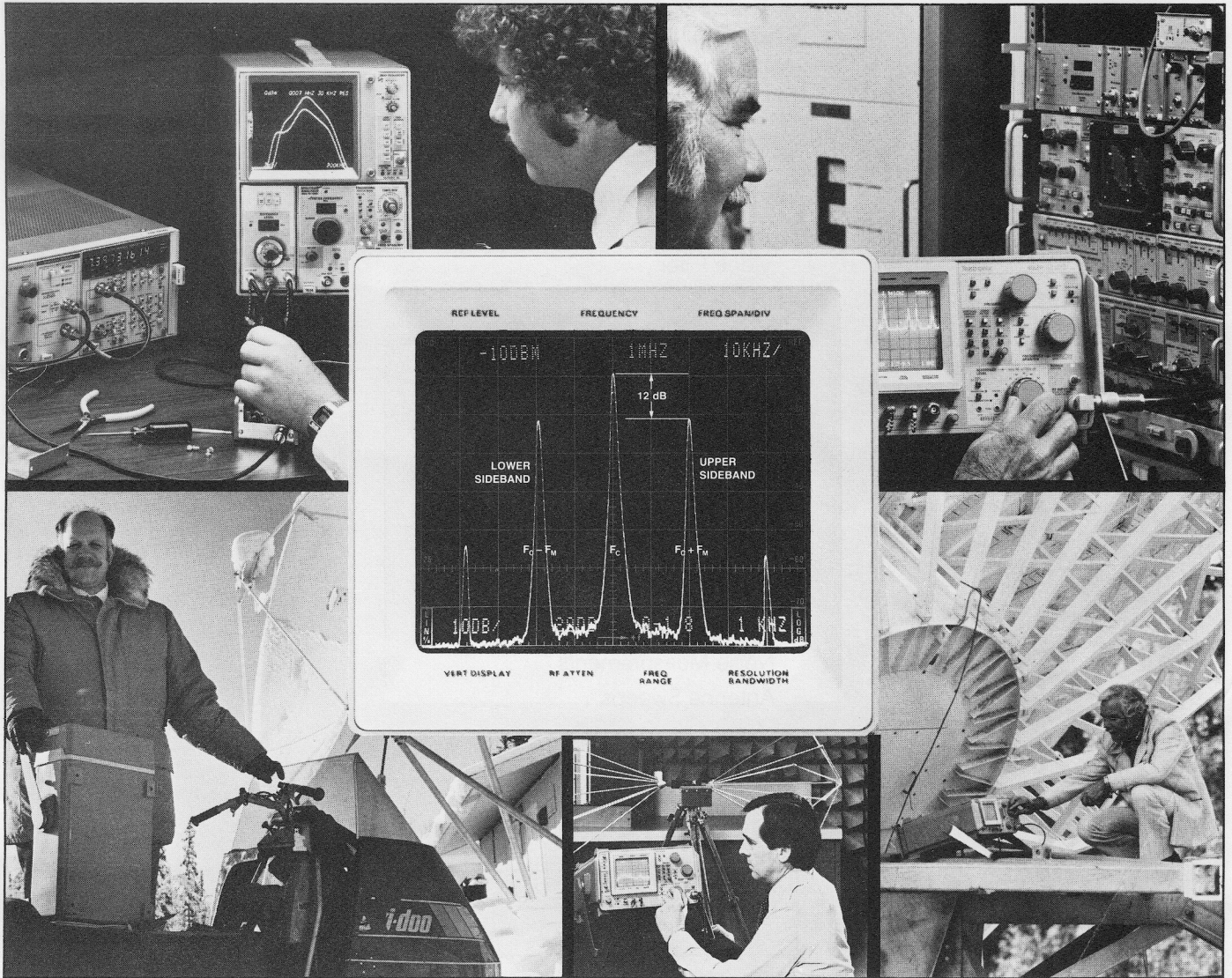

## CONTENTS:

<b>Preface</b> .....	1
<b>Introduction</b> .....	1
Nature of Measurement .....	1
Types of Measurement .....	2
<b>Primary Controls</b> .....	2
Amplitude .....	2
Scale Factor (Vertical Display) .....	2
Reference Level .....	3
Typical Spectrum Analyzer Controls Photo .....	4
Frequency .....	6
Frequency Control .....	6
Span Control .....	6
Resolution Bandwidth .....	6
<b>Secondary Controls</b> .....	7
Sweep Time .....	7
Video Filter .....	8
Digital Storage .....	8
Frequency Range .....	9
Phase Lock .....	9
Preselector .....	9
<b>Applications</b> .....	9
Amplitude Modulation .....	9
Harmonic Distortion .....	10
Intermodulation Distortion .....	11
Tracking Generator .....	11
Pulsed RF (Radar) .....	12
Noise Measurements .....	14
Antenna Sweeps .....	15
<b>Glossary</b> .....	17

*Fundamentals of Spectrum Analysis was written by Bill Benedict,  
Engineering Operations Manager, Frequency Domain Instruments, Tektronix, Inc.*

## Preface

This handbook explains the fundamentals, or basics, of spectrum analysis. It describes the essential controls and how to use them, how to make elementary measurements, and how to interpret the display. There are other articles available from Tektronix, Inc. and others, that describe in more detail the operation of an analyzer and the interpretation of the display. After reading this handbook, an individual familiar with basic electronics and primary electronic communication theory will be able to make basic measurements with an analyzer.

For the best results, use an analyzer when reading the text, especially the section on Primary Controls. The material will be much more meaningful. Trying to duplicate the photos is the most effective way to understand the function of each control. A multi-function signal generator will provide most of the signals used in the photos. Gaining the basic knowledge of how to use a Spectrum Analyzer will make it easier to switch from one model analyzer to another.

This text will not discuss all the controls of an analyzer as many of them are for special functions and will vary between analyzers and manufacturers. The operator's manual for a particular analyzer should be consulted regarding the exact operation of all controls.

## Introduction

### Nature of Measurement

All electrical waveforms or signals are composed of a combination of sinusoidal signals of varying amplitudes and frequencies. The combination of sine waves can be observed in the time domain with an oscilloscope, or in the frequency domain with a Spectrum Analyzer. The oscilloscope enables observation of the amplitude and shape of an

electrical signal during the measurement interval with respect to time. Likewise, a Spectrum Analyzer permits observation of the amplitudes and frequencies of the various discrete sinusoidal signals during the measurement interval. In both cases, the results are displayed on a cathode-ray tube (crt) with the vertical axis being the amplitude scale and the horizontal axis being the time scale for an oscilloscope or the frequency axis for a Spectrum Analyzer. Figures 1, 2, and 3 show various waveforms as displayed on both an oscilloscope and a Spectrum Analyzer.

In the first example, a sine wave is displayed. The oscilloscope displays the peak-to-peak voltage (vertical axis) of the signal with respect to time (horizontal axis). The Spectrum Analyzer shows the same sine wave

where the positive peak (vertical axis) indicates the amplitude of signal and the single signal (horizontal axis) indicates there is only one frequency or sine wave present. [You will note the presence of a zero hertz marker. It is present due to system design of a Spectrum Analyzer and is present regardless of the input signal. All signals to the left of the zero hertz marker are not negative frequencies as one might think; they are images or reflections of those signals to the right of the zero hertz marker].

The second example (Fig. 2) is a modulated carrier where both the modulation frequency and carrier frequency can be determined. The Spectrum Analyzer indicates the carrier as the larger signal and the modulation as the two smaller signals (upper and lower sidebands).

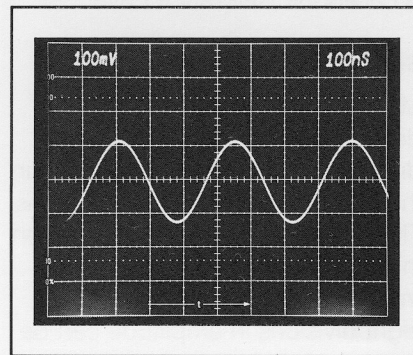

Oscilloscope Waveform: 3 MHz Sine Wave

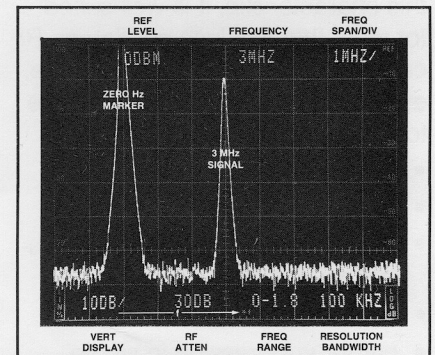

Spectrum Analyzer Waveform: 3 MHz Sine Wave

Figure 1.

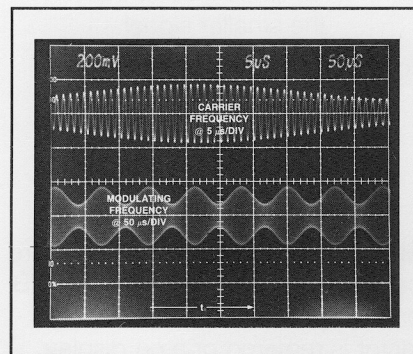

Oscilloscope Waveform: Modulated Carrier at 1 MHz, 15 kHz Modulation

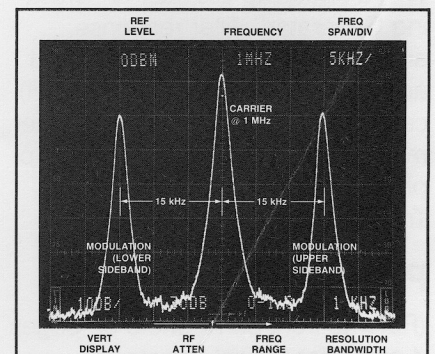

Spectrum Analyzer Waveform: Modulated Carrier at 1 MHz, 15 kHz Modulation

Figure 2.

The third example (Fig. 3) shows the signal appearing on the oscilloscope as a square wave. The Spectrum Analyzer displays a "fundamental" sine wave at the same frequency as the square wave and the other frequencies of diminishing amplitude (as the frequency increases) that make up a square wave. These other frequencies are identified as the 3rd, 5th, 7th, etc. (odd) harmonics of the fundamental frequency.

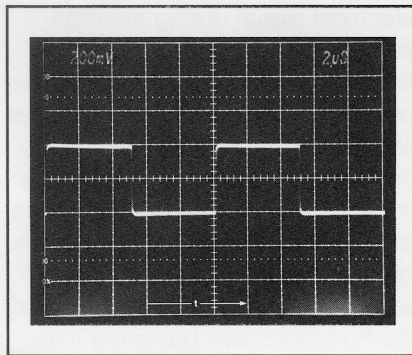

Oscilloscope Waveform: 100 kHz Square Wave

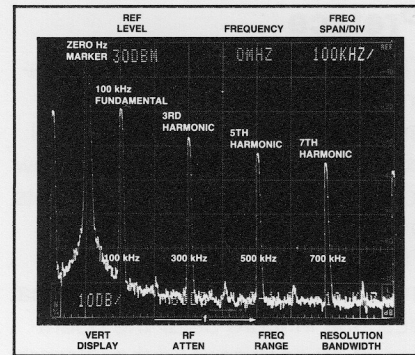

Spectrum Analyzer Waveform: 100 kHz Square Wave

Figure 3.

## Types of Measurements

Composite voltage waveforms are displayed by an oscilloscope. The Spectrum Analyzer, as the name implies, analyzes the composite waveform and displays the individual frequency components and the relative power each component contributes to the total waveform.

Since the Spectrum Analyzer has this characteristic, it is well suited for work that involves oscillators, RF carriers, RF spectrum surveillance, etc. With an analyzer, it is possible to observe:

- an oscillator
- RF carrier
- amount and frequency of modulation
- unexpected modulation
- carrier suppression in single sideband radio
- harmonic level of oscillators and RF carriers

With a sweeping oscillator or "Tracking Generator", filter response, amplifier frequency response, and antenna standing wave ratio (SWR) can all be checked, along with other measurements described in the Applications section dealing with the Tracking Generator.

## Primary Controls

(Refer to front panel photo on pages 4 and 5 for typical Spectrum Analyzer controls).

## Amplitude

The Spectrum Analyzer has two major amplitude controls. The first controls the scale factor (volts/div or dB/div) and the second determines what input signal amplitude is necessary to produce a signal display up to the top line on the crt, which is called the Reference Level.

### Scale Factor (Vertical Display)

Most oscilloscope graticules are divided vertically into eight major divisions. Each major division is further divided into five minor divisions. Thus, a signal of one minor division in amplitude can be accurately measured and another signal of eight divisions in amplitude can be measured and compared to determine the larger one as being

$$\frac{8 \text{ div (5 minor div/div)}}{1 \text{ minor division}} = 40 \text{ times greater than the smaller signal.}$$

To determine this ratio in dB, use

$$\begin{aligned} \text{dB} &= 20 \log \frac{V_2}{V_1} \\ &= 20 \log \frac{40}{1} = 32 \text{ dB.} \end{aligned}$$

Since many Spectrum Analyzers are capable of displaying ratios of 80 dB on screen, either a different scale factor is required or a crt display with 2,000 major vertical divisions is required! The obvious solution is to use a logarithmic scale of 10 dB/div

with the standard eight division screen to display 80 dB of range. As an example, with 80 dB of on-screen range, two signals can be measured simultaneously; one of 1 W (+30 dBm) and the other of 0.01  $\mu$ W (-50 dBm). That is a voltage ratio of 10,000:1, far greater than the 40:1 ratio possible with the oscilloscope.

Before going further, note the basic equations that can be used to convert to dB, dBm, dBV, and dBmV. Once you begin to use the Spectrum Analyzer, you will find that most measurements will be in dB or dBm and no conversion will be necessary. It is not important that you conquer these equations before going further.

Signal ratios are expressed in dB:

$$\begin{aligned} \text{dB} &= 20 \log \frac{\text{Voltage (2)}}{\text{Voltage (1)}} \\ \text{or } 10 \log \frac{\text{Power (2)}}{\text{Power (1)}} \end{aligned}$$

Power into a known load (50, 75, 600 ohms, etc.) is expressed in:

$$\text{dBm} = 10 \log \frac{\text{Power}^*}{1 \text{ mW}}$$

\* (at specified impedance)

$$\text{dBV} = 20 \log \frac{V(1)^*}{1 \text{ V}}$$

$$\text{dBmV} = 20 \log \frac{V(1)^*}{1 \text{ mV}}$$

\* (volts are RMS volts)

The obvious problem with having a scale factor that allows such a large range of signals on screen simultaneously is that two signals appear

ing close in amplitude may in reality vary significantly in amplitude. As an example, assume there is one signal of 1 mW and another signal of 2 mW power. Using the equations, it is apparent they are

$$10 \log \frac{2 \text{ mW}}{1 \text{ mW}} = 10 \log 2 = 3 \text{ dB}$$

apart in amplitude, or 1.5 minor divisions with a scale factor of 10 dB/div. To allow accurate measurements of signals of close amplitudes, an analyzer typically has a Display Mode of 2 dB/div where, as in the previous example of two signals being 3 dB apart (2X), the display would indicate 1.5 major divisions of separation. A third common display mode is linear scale factor, where the RMS value of the signal is displayed with a calibration of volts/div.

### Reference Level

The Reference Level is one of the three main controls of a Spectrum Analyzer. The purpose of this control is to obtain an adequate display of signal amplitude on screen. This control sets the level of the signal necessary to produce a full-screen deflection (i.e., the top of the screen is the Reference Line). Thus, if the Reference Level control is set for 0 dBm with a Vertical Display of 10 dB/div, a 0 dBm signal would rise to the top crt graticule marking. A -20 dBm signal would be 2 divisions down from the top [0 dBm - 2 div (10 dB/div) = -20 dBm].

Some analyzers separate the Reference Level control into two individual controls. Together they represent the Reference Level, but separately each controls an individual section of the analyzer. The two independent sections of the analyzer are the RF Attenuator control and the IF Gain control.

The RF Attenuator control selects the amount of RF attenuation the signal experiences just after it enters the analyzer. For optimum analyzer performance, the input signal must be attenuated to a level specified by

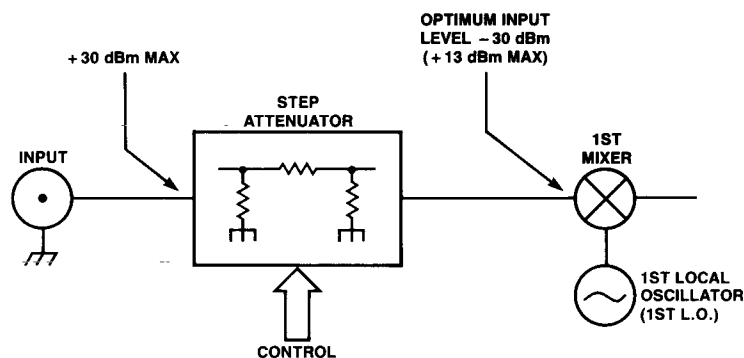

Figure 4. Spectrum Analyzer Input Indicating Point of Optimum Input Level.

the manufacturer for the 1st mixer (optimum input level, see Fig. 4). For example, Tektronix 490 Series Spectrum Analyzers have an optimum signal level for the 1st mixer of -30 dBm. Therefore, if the signal being measured with the analyzer is -10 dBm in level, the RF attenuator should be set for 20 dB of attenuation. The first mixer would then see: -10 dBm (input) -20 dB (attenuation) = -30 dBm (1st mixer level).

The IF Gain control selects the proper amount of gain within an amplifier stage to keep the instrument within amplitude calibration. This control does not have any restrictions for proper operation.

Some analyzers, like the Tektronix 490 Series, contain a microprocessor that selects the proper ratio of RF attenuation and IF gain, depending on the Reference Level selected. This eases operator responsibility, because the operator is only required to keep the signal at or below the top graticule line by selecting an appropriate Reference Level.

All analyzers have a maximum input level that must be observed. Typically, this level is +30 dBm (1 W). It is extremely important to observe this limit, because extensive and expensive damage may occur to the input circuitry. Usually, both the RF attenuator and the 1st mixer have a maximum input level, and quite often they are not the same level. The RF attenuator can handle a significantly larger signal level than the 1st mixer

without damage. Therefore, if you are unsure of the level of the input signal, select the largest RF attenuation available. Once the signal is displayed on the screen, the attenuation can be removed one step at a time to bring the largest signal to the top of the screen. Typically, if the input is less than 0 dBm, the analyzer will not be damaged regardless of how the Reference Level controls are set.

Most RF power meters indicate the total amount of power available at the head of the power meter from all signals present on the cable. Thus, if there are many discrete sinusoidal signals present on the cable, the amplitude of any one signal cannot be determined with the power meter. The Spectrum Analyzer allows each signal to be viewed separately for both amplitude and frequency. However, the input (attenuator and 1st mixer) circuitry is like the power meter in that it is exposed to all signals present. Therefore, the rules regarding maximum input level apply to the sum of all signals present on the input, regardless of whether they are all being displayed on the screen or not. As an example, if two signals of +20 dBm and one of -50 dBm are present on a cable, the input circuitry is actually being exposed to over +23 dBm. Remember (from a previous example), if you double the power, you have a signal level 3 dB higher [(+20 dBm) + (+20 dBm) ≥ (+23 dBm)]. With over +23 dBm on

**VERTICAL DISPLAY:  
SCALE FACTOR FOR  
VERTICAL DEFLECTION (i.e.  
Y-AXIS SCALE FACTOR)**

**TRIGGERING:  
SELECTS MODE OF  
TRIGGERING SWEEP**

**TIME/DIV:  
SELECTS RATE AT WHICH  
FREQUENCY SPECTRUM IS  
ANALYZED**

**CALIBRATOR:  
PROVIDES ACCURATE  
SIGNAL FOR AMPLITUDE  
AND FREQUENCY  
CALIBRATION**

**REFERENCE LEVEL:  
DEFINES AMPLITUDE (LEVEL)  
OF SIGNAL NECESSARY FOR  
FULL SCREEN DEFLECTION**

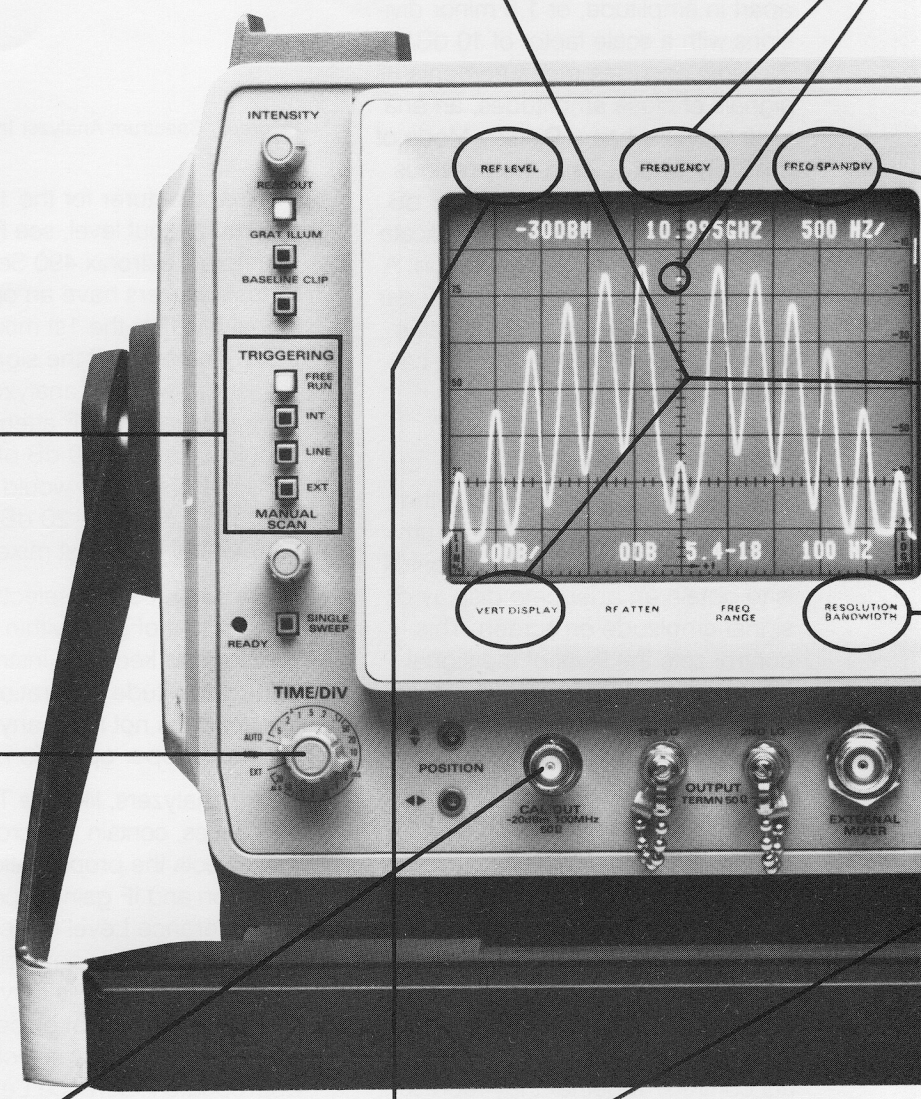

**FREQUENCY:**  
DEFINES FREQUENCY  
WHICH REFERENCE DOT  
ON SCREEN REPRESENTS

**FREQUENCY RANGE:**  
SELECTS FREQUENCY BAND  
OF ANALYSIS (INDICATED  
ON LOWER SCREEN  
READOUT)

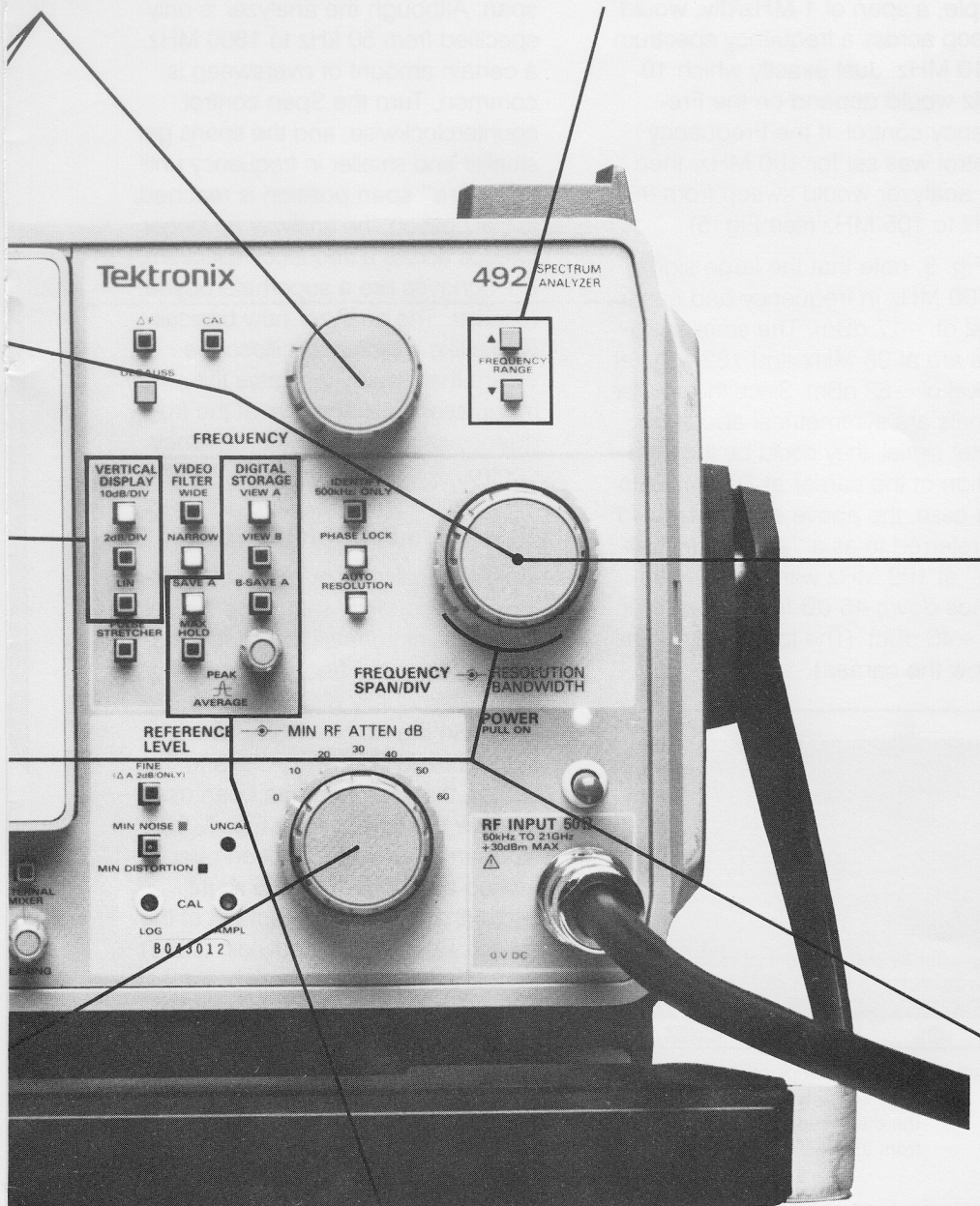

**FREQUENCY SPAN/DIV:**  
CONTROLS MAGNITUDE OF  
FREQUENCY SPECTRUM BEING  
ANALYZED (i.e., X-AXIS  
SCALE FACTOR)

**RESOLUTION BANDWIDTH:**  
DEFINES ABILITY OF  
ANALYZER TO IDENTIFY  
ADJACENT SIGNALS

**DIGITAL STORAGE:**  
SELECTS MODES OF  
ACQUIRING AND DISPLAYING  
SIGNALS FOR PRESENTATION  
ON SCREEN

the input and a 1st mixer that works best with  $-30$  dBm, we need 53 dB of attenuation for optimum operation [ $+23$  dBm (input)  $-53$  dB (attenuation) =  $-30$  dBm (1st mixer signal level)]. If the analyzer is tuned to shift the larger signals off screen, the RF attenuation still cannot be removed to shift the  $-50$  dBm signal up on screen for better viewing, because the input circuitry is still being exposed to the two larger signals. However, IF gain may be added to increase the displayed level of the smaller signal.

Unlike an oscilloscope, a Spectrum Analyzer is ordinarily susceptible to damage from dc voltages. This is extremely important to remember. If a dc voltage can be applied to an analyzer, it will usually be indicated on the front panel near the input connector. If dc voltage is a possibility, always use an external Blocking Capacitor. Suitable blocking capacitors with good VSWR are available from several vendors.

## Frequency

### Frequency Control

The Frequency control is the second of the three main controls. This control identifies the frequency of a particular point on the display. Customarily, this is the center of the screen. In some modes of operation, however, it could be some other point on the screen. On many analyzers, there is a dot or other indication on the display that indicates the point on screen that represents the specified frequency.

### Span Control

The Span control or Span/div control is the third of the three main controls. With this control, the width of the frequency spectrum being analyzed can be varied. When referred to as Span/div, it indicates "X" Hz/division; therefore, a 10 division screen would be sweeping across a frequency spectrum of  $10 \times "X"$  Hz. (An ana-

lyzer that defines the Span control as just "span" will sweep that many "Hz" across the screen.) As an example, a span of 1 MHz/div, would sweep across a frequency spectrum of 10 MHz. Just exactly which 10 MHz would depend on the Frequency control. If the Frequency control was set for 100 MHz, then the analyzer would sweep from 95 MHz to 105 MHz (see Fig. 5).

In Fig. 5, note that the large signal is 100 MHz in frequency and has a level of  $-17$  dBm. The smaller signals are at 98 MHz and 102 MHz at a level of  $-62$  dBm. Since the smaller signals are symmetrical about the center signal, they could be the modulation of the carrier at 100 MHz. In that case, the above example would be referred to as a "signal" or "carrier" at 100 MHz with 2 MHz sidebands down 45 dB from the carrier (or  $-45$  dBc). (The term dBc means below the carrier.)

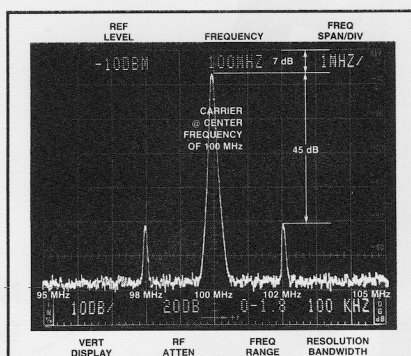

Figure 5. With Frequency control set at 100 MHz and a Span of 1 MHz/div, the displayed spectrum extends from 95 MHz to 105 MHz.

The Span control has two settings that are not calibrated in hertz. Turn this control clockwise to eventually reach a position of maximum (MAX) span. In this position, the analyzer sweeps across its maximum frequency spectrum for the band of frequencies selected. In a "band" that extends from 0 Hz to 1800 MHz,

the analyzer sweeps the frequency spectrum from 0 Hz to 1800 MHz to look for signals when in MAX span. Although the analyzer is only specified from 50 kHz to 1800 MHz, a certain amount of oversweep is common. Turn the Span control counterclockwise, and the spans get smaller and smaller in frequency until the "zero" span position is reached. In this position, the analyzer no longer sweeps across a frequency spectrum, but behaves like a superheterodyne receiver. The analyzer now basically works like a typical oscilloscope where the display indicates the modulation of any signal at the frequency selected by the Frequency control.

### Resolution Bandwidth (RBW)

Ideally, the display or graph of amplitude vs. frequency should be vertical lines of minimum width to allow signals of very close frequency spacing to be individually discernible as shown in Fig. 6. Note the pair of sidebands located very close to the carrier. If a wide pen had been used to draw the figure, as in Fig. 7, the sidebands might have been overlooked as denoted by the slight width change near the bottom of the carrier. Resolution Bandwidth (RBW) performs much the same function as varying the width of the pen when plotting the display on the screen. As the frequency spectrum being displayed on screen varies as a function of the span/div, the width of the "pen" that is calibrated in hertz must also change. If an extremely narrow "pen" is used with an extremely wide frequency span, signals will appear very narrow and may be overlooked.

Most modern Spectrum Analyzers through the use of microprocessors have the capability to select the optimum bandwidth (resolution bandwidth) depending on the span/div and time/div selected. There will be times, however, when manual control of this function will be desired.



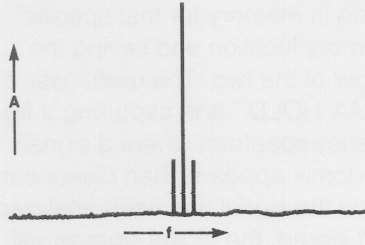

Figure 6. Spectral graph drawn with fine tip pen clearly showing closely spaced signals.

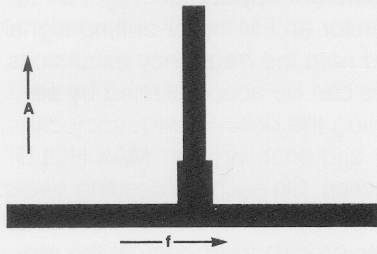

Figure 7. Spectral graph drawn with broad tip pen masking closely spaced signals.

Resolution Bandwidth is a functional control that selects one of several bandpass filters physically located in the instrument's Intermediate Frequency (IF) chain. It is defined in the term Hertz (Hz) and is a measure of the width of the filter either 3 dB or 6 dB down from its peak, depending on analyzer manufacturer. The shape of the signals being traced out on screen are, in reality, a combination of the shape of the Resolution Bandwidth filter, and the signal, not just the shape of the signal being analyzed.

The limitations imposed on an analyzer by the Resolution Bandwidth filter are significant. Sweep speed (the rate the analyzer sweeps through the frequencies present) must be slow enough to allow the filters to reach peak amplitude or an inaccurate signal amplitude will result. When analyzing pulse type signals such as radar, Resolution Bandwidth is very important or erroneous results will be obtained. This application will be covered in more detail in the Applications section.

Unless a special requirement dictates a specific Resolution Bandwidth, the Resolution Bandwidth selected should be somewhat greater than 1/50 the span/div. Figs. 8 and 9 show the two extremes of useful Resolution Bandwidth for a particular span. In each case, the signal being displayed is the same, with only the Resolution Bandwidth of the analyzer changing between the two figures. Fig. 8 is displayed with an extremely wide RBW for the span/div selected. Fig. 9 has a more optimum RBW selected, and we can now see sidebands on the signal that were not visible in Fig. 8. If the bandwidth continued to narrow, the sweep speed of the analyzer would have to slow down to allow the signal to trace the correct amplitude through the filter, and the display would be less viewable.

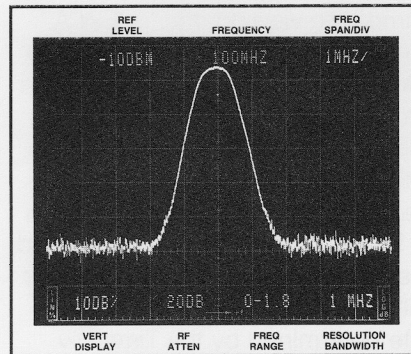

Figure 8. 1 MHz RBW. Wider Than Optimum Bandwidth

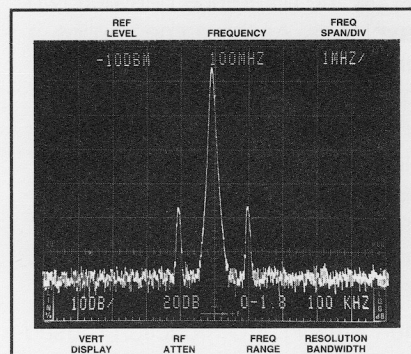

Figure 9. 100 kHz RBW. Optimum Bandwidth Showing Signals Masked By Filter Skirts in Figure 8.

Another characteristic not yet mentioned, which works in our favor, is that as the RBW is decreased, the noise floor of the analyzer goes down. (The term noise floor refers to the baseline or lowest horizontal part of the trace. Because of its appearance, this part of the signal is sometimes referred to as the "grass".) For each decade decrease in RBW (e.g. from 100 kHz to 10 kHz), the noise floor of the analyzer decreases by 10 dB. This is extremely important when looking for very small signals.

Figure 10 is a composite of two RBW's that show a signal which was initially buried in the noise. The only parameter changed is the RBW, which in effect, pushed the noise of the analyzer below the level of the signal's sidebands.

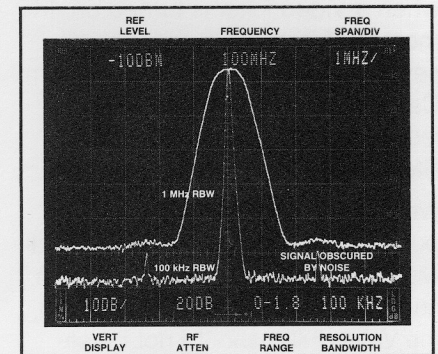

Figure 10. Composite photograph illustrating sidebands obscured by noise in wider resolution bandwidth.

## Secondary Controls

### Sweep Time

Like Resolution Bandwidth, most newer analyzers have an Auto position in which a microprocessor selects the optimum sweep speed, depending on other parameters. When analyzing a frequency spectrum, this control determines the rate at which the analyzer sweeps through the determined spectrum. If the spectrum is swept too fast, the RBW filters may ring or fail to reach full amplitude. If swept too slow, there are no disadvantages, unless the analyzer does not have "digital storage" or some form of waveform storage. Without

storage, by the time an extremely slow sweep is complete, the operator could have forgotten the content of the original spectrum.

When the analyzer Span/div control is set for Zero Span, the Sweep control functions like an oscilloscope's time control. As previously described, the display is a time domain presentation of the modulation at the center frequency selected when in Zero Span.

### **Video Filter (sometimes referred to as a Noise Averaging Filter)**

This filter is used primarily as a smoothing filter to remove or smooth out the short duration noise spikes at the bottom of the display. When the analyzer is in Auto sweep speed, note that the sweep rate decreases when a Video Filter is turned on. In most analyzers there are usually several Video Filters to choose from. Care must be taken, much like selecting the Resolution Bandwidth filter.

When analyzing a signal such as pulse radar or if the Resolution Bandwidth is very narrow for the span (i.e., narrow signals displayed on screen), the Video Filter should not be selected, as this will not allow the amplitude of the analyzed signals to reach full amplitude due to its video bandwidth limiting property (i.e., a low-pass filter).

### **Digital Storage**

In many older Spectrum Analyzers, a storage oscilloscope was used as the display. This was necessary because of the slow sweep speeds required to maintain amplitude calibration. With the advances in digital hardware, it is now possible to divide the screen into small horizontal segments and digitize the amplitude as the analyzer sweeps through each segment and store the data in RAM (random access memory). This data can then be accessed, converted to analog signals, and sequentially displayed on the screen in the proper

horizontal sequence at slightly above flicker rate.

This procedure of digitizing a signal occurs after the signal has been processed by the Resolution Bandwidth (RBW) circuitry, the Logarithmic (log) circuitry, and Video Filter circuitry. It usually occurs just prior to being amplified for the crt.

Once the data is stored in RAM, we usually have an option as to the method of display. If we desire to "SAVE" a particular waveform (e.g., "A" waveform), we can select the "SAVE A" function and the "A memory" within the analyzer will be frozen and not updated. The B waveform in memory will continue to be updated with each sweep of the analyzer; thus we would view separate traces on the screen. If the "SAVED" trace was not needed for immediate viewing, the "VIEW A" function could be disabled and the "A memory" would not be displayed on the screen; but, its data would still be available for future reference. If the "VIEW B" function is simultaneously disabled, the display portion of Digital Storage is disengaged and the sweeping signal of the analyzer will be displayed, with the refresh rate determined by the Time/Div control.

The "B-SAVE A" control is used to display the difference between two waveforms. As the name implies, it subtracts the SAVED A waveform from the active B waveform. This function is most useful when the analyzer is used with the Tracking Generator. (This application will be discussed in the Applications section dealing with the Tracking Generator.)

The "MAX HOLD" function is used to capture the maximum Y deflection (amplitude) for any X axis position (frequency), regardless of how many sweeps must be made to capture these extremes. This is accomplished by the digital storage digitizing new amplitude data for a particular point on screen, then checking the amp-

litude in memory for that specific memory location and saving the larger of the two. The usefulness of "MAX HOLD" is in capturing a frequency spectrum where a signal randomly appears, then disappears. Once the signal has been analyzed and stored, the digital storage will continue to display the signal, regardless of whether or not it reappears on succeeding sweeps.

A different application might be to monitor an FM'ing or drifting signal and note the frequency excursions. This can be accomplished by selecting the desired frequency carrier and enabling the "MAX HOLD" function. On each succeeding sweep, the analyzer will analyze the carrier at its precise frequency at the moment of analysis and save this value in memory. With repetitive sweeps, the maximum excursions will be filled and viewable for analysis. It is important to check the drift specifications of the analyzer to ensure the analyzer is more stable than the signal to be checked.

The Peak/Average cursor is used to determine data processing prior to loading the digitized information in RAM for a particular horizontal point on the screen. For each horizontal point on the screen (of which there are 1000) the digitizer may digitize from 2 to 10,000 samples (depending on the sweep speed) to represent the Y value to be stored for a particular horizontal point. If the amplitude of the signal at this horizontal point is above the cursor, the storage will select the maximum value digitized and load this number in memory; thus, the term "Peak Detect". When the amplitude of the signal at this horizontal point is located below the cursor, the digital storage will take the mathematical average of the digitized numbers and load this number in memory; thus, the term "Average Detect".

The necessity for having a "Peak/Average" function is to ensure that the maximum value of a narrow

pulse can be stored to represent the maximum amplitude of that pulse, and "noise" or "grass" can be averaged before storing in RAM to offer the maximum possible signal-to-noise ratio.

### Frequency Range

This function operates much like a "Band Select" switch on a short-wave receiver. Each succeeding selection of either the "up" or "down" control will place the instrument in a higher or lower frequency band of operation.

### Phase Lock

An analyzer usually has two or more internal oscillators, one or more of which will be swept (or moved) as the analyzer is sweeping through a frequency spectrum. When in wide spans, such as 100 kHz/div or greater, a slight amount of drift in one of the internal oscillators is usually not noticeable. However, as the span is reduced to several kHz/div or less, the instability of the internal oscillators becomes apparent. The screen indication is of an apparently drifting signal, when the real problem is a drifting oscillator within the analyzer. Therefore, when an analyzer is operating in the narrower spans, the oscillator causing the drift problem is typically phase locked to a stable reference to prevent the drift. In wider spans/div, this oscillator is typically being swept; therefore, it cannot be locked at all times. When the phase lock circuitry is operating, a front-panel indicator will typically inform the operator. This indication requires no action on the user's part and will usually not affect the measurement in an adverse way.

### Preselector

A Preselector is a filter located just slightly behind the input connector. The function of the filter is to select or allow only a narrow band of frequen-

cies to pass into the analyzer. It is a sweeping filter that tracks the frequency the analyzer is tuned to at any particular point in time. The function it performs is to inhibit harmonic mixing within the first converter. By eliminating the harmonic conversions, unwanted mixing products do not appear as signals in the spectrum. In addition, any large signals (up to +30 dBm) present on the input but out of the frequency range being analyzed are prohibited from reaching the input mixer, thus eliminating the need to use attenuation to protect the input mixer from burnout. The preselector is almost transparent to the user, except that it needs to be "peaked" occasionally. This is usually accomplished with a front-panel control. The "Peaking Control" allows the user to offset the tracking filter slightly forward or backward with respect to the frequency the analyzer is tuned (i.e., to be centered around the tuned frequency). If the filter is mis-peaked and is completely offset from the tuned frequency, the analyzer will indicate a complete lack of signals in the preselected bands. Preselection occurs only in bands 2 through 5 (1.7 — 21 GHz) in the 490 Series of Spectrum Analyzers.

## Applications

### Amplitude Modulation (AM) Notes

An Amplitude Modulated signal, when viewed in the time domain (as with an oscilloscope), might appear as in Fig. 11. From this photo, we can determine the frequency of the carrier (fc) and the frequency of the modulation (fm). In addition, the percent of modulation can be calculated from the equation:

$$\% \text{Mod} = \frac{E_{\max} - E_{\min}}{E_{\max} + E_{\min}} \times 100.$$

Figure 12 represents the same signal being displayed in the frequency domain on a spectrum analyzer.

From this display, the frequency of the carrier (fc) and the frequency of the modulation (fm) can also be determined. The percent of modulation can also be determined by noting the difference in amplitude (12 dB) between fc and fm and using the table in Fig. 13.

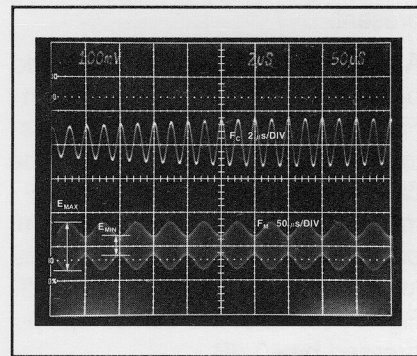

Figure 11. AM Modulation (50%) in time domain.

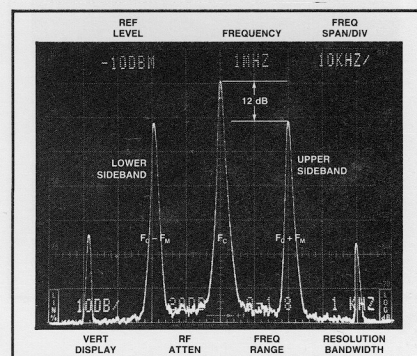

Figure 12. AM Modulation in frequency domain.

$$\% \text{ Modulation} = 200 \times 10 \frac{-(\text{dB down from Carrier})}{20}$$

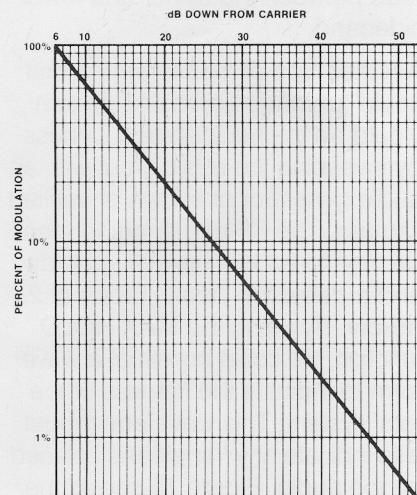

Figure 13. Chart of dB vs. % of Modulation.

Figures 11 and 12 were prepared under controlled test conditions. In normal operation, the modulation will not be a pure sine wave, but will be a composite of multiple sine waves, and their frequencies cannot be determined in the time domain. However, the Spectrum Analyzer will accurately display all frequencies present.

A suppressed carrier system would be displayed on the analyzer as in Fig. 14. The typical measurements to be made in this system would be carrier suppression. The measurement is the difference in carrier amplitude between when the carrier is turned on and when it is turned off. Fig. 14 indicates the carrier is suppressed by 40 dB.

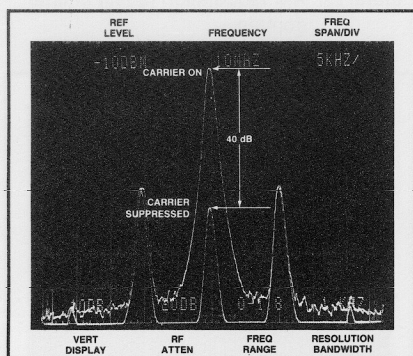

Figure 14. Suppressed Carrier System

Similarly, if the lower sideband was suppressed as well, we could determine the amount of this suppression by noting the difference in amplitude between the upper and lower sideband.

Another type of measurement that could be made on an AM system would be to check system flatness by sweeping the audio input with an audio generator of known or verified flatness. The RF carrier could then be monitored in a narrow span/div and a deflection (scale) factor of 2 dB/div. By using the MAX HOLD function, we could construct a waveform to indicate the flatness of the total system. This waveform would also indicate any "emphasis" placed on the audio. Figure 15 shows the

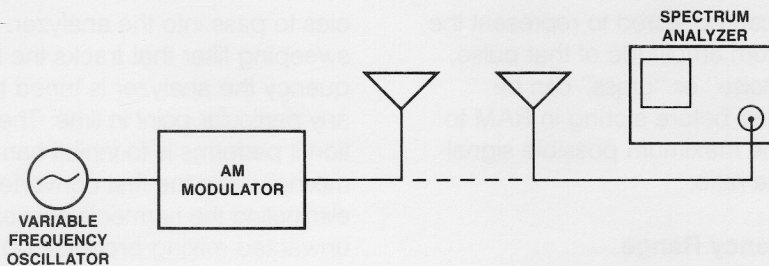

Figure 15. Test setup for sweeping audio flatness.

system described, and Fig. 16 is a photo of such a sweep.

From Fig. 16 we can see the system flatness is 1.3 dB (which in reality may be a type of emphasis placed on the audio), and the system 3 dB bandwidth is in excess of 8 kHz. Both lower and upper sideband envelopes should be symmetrical. If the transmitter were seriously mistuned or was working into a poor antenna match, the Spectrum Analyzer would show how each sideband was individually affected.

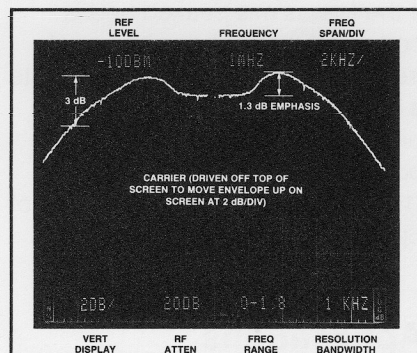

Figure 16. Audio flatness of AM system as measured at RF frequency.

### Distortion

Distortion is the result of electronic circuits operating in a non-linear mode. Two of the most common methods of checking for distortion involve driving the equipment with known signals and monitoring the equipment output for signals other than those present at the input.

**(Harmonic Distortion)** A typical Harmonic Distortion measurement would be set up as in Fig. 15 with the variable frequency oscillator set at some specified frequency. The

modulator should be driven to a specified percent of modulation and the Spectrum Analyzer should be checked for the presence of only the signal that is put into the modulator. If harmonic distortion is occurring, additional products will appear on the screen at multiples of the modulating frequency. Fig. 17 shows the result of a modulator being driven with a 5 kHz test signal. Harmonic distortion will show up as signals at 10 kHz, 15 kHz, 20 kHz, etc. from the carrier. The Total Harmonic Distortion (THD) can be determined by noting the amplitude difference between the modulation signal and its harmonic products.

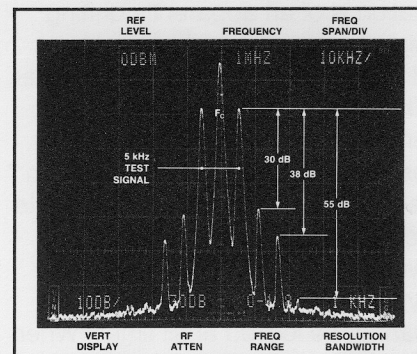

Figure 17. Harmonic Distortion at 10 kHz, 15 kHz, and 20 kHz from Carrier.

The sum of all the harmonic products must be used to determine the percent of harmonic distortion. The Total Harmonic Distortion (THD) can be determined by noting at what level below the fundamental each harmonic lies, and determining the percent ratio for each harmonic from Fig. 18 and substituting in the following equation. This equation is only accurate if the upper and lower

harmonic pairs are within one or two dB of each other.

$$\text{THD}(\%) = \sqrt{(2\text{nd Harmonic } \%)^2 + (3\text{rd Harmonic } \%)^2 + (4\text{th Harmonic } \%)^2 + \text{etc.}}$$

From Fig. 17, the THD is

$$\sqrt{0.0325^2 + 0.012^2 + 0.0018^2} = 0.035 = 3.5\%$$

When making this measurement, it is important to be sure the modulating signal from the audio oscillator is free from any harmonics. To do this, check the signal source with a Spectrum Analyzer.

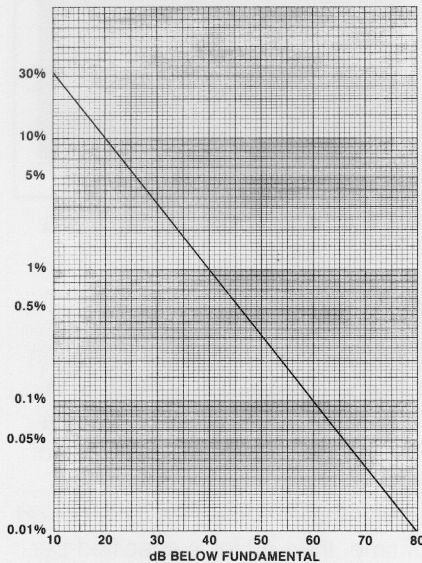

Figure 18. dB below Fundamental to % Distortion.

**(Intermodulation Distortion)** An additional measurement common to amplifiers or transmitters is the Two Tone Intermodulation Distortion (IM) test. This test is similar to the Harmonic Distortion check, except it requires an additional audio signal generator. The two audio generators are combined, and the result is applied to the modulator. The method of combining the two signals is very important, as mixing the two sources with each other can create unwanted products. Combining should occur in a directional bridge. A "T" connection or combiner can be used, provided each generator is sufficiently padded. A

Spectrum Analyzer should be used to check the output of the directional bridge or combiner for any signals other than those applied prior to modulating the transmitter. The frequency of the modulating signals depend on the type of test to be performed and the type of equipment being checked. Our example uses a 4 kHz ( $f_1$ ) and 5 kHz ( $f_2$ ) signal. There are multiple IM products created, of which the first one is called the second order IM product, which will occur around the carrier at  $f_1 + f_2$ ,  $f_1 - f_2$  and/or  $f_2 - f_1$  (9 kHz and 1 kHz from the carrier). The third order IM products will occur at  $2f_1 + f_2$ ,  $2f_1 - f_2$ ,  $2f_2 + f_1$ , and/or  $2f_2 - f_1$  (13 kHz, 3 kHz, 14 kHz, and 6 kHz, from the carrier.) Fig. 19 shows a typical response and identifies the various 2nd and 3rd order products.

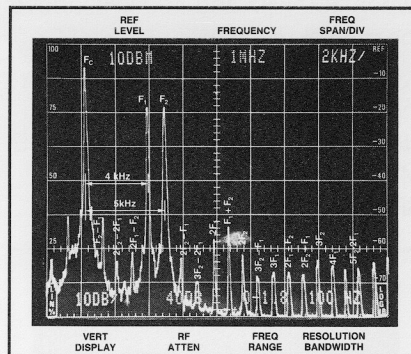

Figure 19. Distortion showing input signals and both Harmonic Distortion ( $2f_1$ ,  $2f_2$ , etc.) and IM products (second order:  $f_2 - f_1$ ,  $f_1 + f_2$ ), (3rd order:  $2f_1 - f_2$ ,  $2f_2 - f_1$ ,  $2f_1 + f_2$ ,  $2f_2 + f_1$ ), plus higher order products.

For more information on these and other tests on AM systems, see Tektronix, Inc. Application Notes AX-3266, "AM BROADCAST MEASUREMENTS USING THE SPECTRUM ANALYZER", and 26W-4889, "NO LOOSE ENDS — REVISED. THE TEKTRONIX PROOF OF PERFORMANCE PROGRAM FOR CATV."

### Tracking Generator — TG (with Spectrum Analyzer for Swept Measurements)

A Tracking Generator (TG), when used in conjunction with a Spectrum Analyzer (SA), allows such items as filters, amplifiers, couplers, etc. to be observed with respect to frequency (i.e., Frequency Response). This is performed by connecting the output of the TG (TG output frequency is synchronized to frequency being analyzed by Analyzer at any point in time i.e., "Tracking Generator") to the input of the device being tested, and monitoring the output of the device with the SA (as shown in Fig. 20). This type of measurement is known as an S12 magnitude only measurement, since the phase shift of the signal through the device is not displayed.

The response displayed on the screen of the analyzer will be a combination of the unflatness of the TG and the response of the device being tested. The unflatness of the

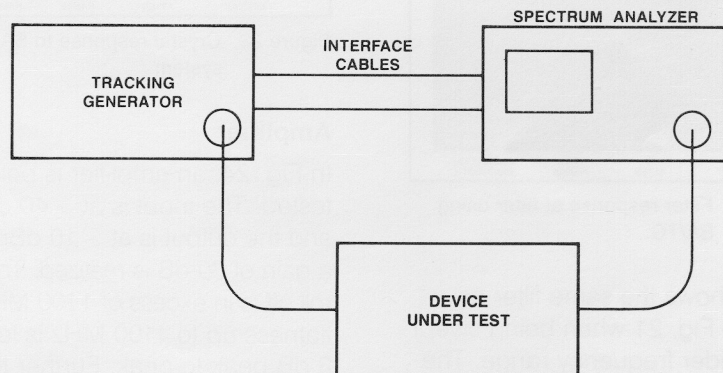

Figure 20. Spectrum Analyzer (SA) and Tracking Generator (TG) Test Setup.

TG/SA can be removed by using the "B-Save A" function of the SA. First, connect the TG to the SA and save the flatness (or unflatness) of the TG/SA in the A memory by using the SA "Save" function, and using the "Vert Display" mode that will be used in the measurement. Then, connect the TG to the device being tested and monitor the device with the analyzer. Once a sweep has been made, the analyzer display will indicate the system response. By activating B-Save A, the saved unflatness of the TG will be subtracted from the response of the system, and the corrected display will indicate the corrected frequency response of the device being tested. The photographs that follow indicate the typical responses of the systems shown.

**Filter**

Figure 21 shows a 9 MHz filter being swept with a SA/TG system. We can determine the filter loss as being approximately 8 dB by noting the difference in amplitude between the TG response and the filter response. The filter is approximately 400 kHz wide 3 dB down from the peak. Note the unsymmetrical shape near the base of the filter. The filter ultimate is better than 68 dB.

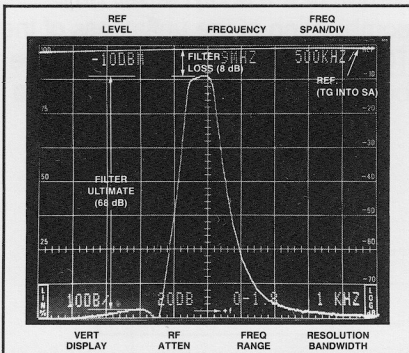

Figure 21. Filter response of filter using SA/TG.

Fig. 22 shows the same filter as shown in Fig. 21 when being swept over a wider frequency range. The filter is being tested from 0-900 MHz. At 350 MHz we can see the filter is

only capable of 7 dB of ultimate due to a re-entrant mode.

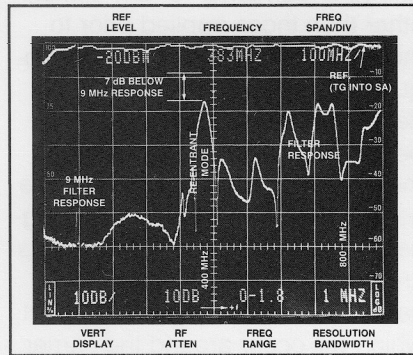

Figure 22. Filter response at wide sweep indicating re-entrant mode.

**Crystal**

Fig. 23 shows the response of a crystal. The series resonance ( $f_s$ ) and parallel resonance ( $f_p$ ) frequencies are identified on the photo. Also note the crystal spurs located between 300 kHz and 400 kHz above the crystal resonance.

For more information on crystal testing, see Tektronix, Inc. Application Note AX-3525, "CRYSTAL DEVICE MEASUREMENTS USING THE SPECTRUM ANALYZER."

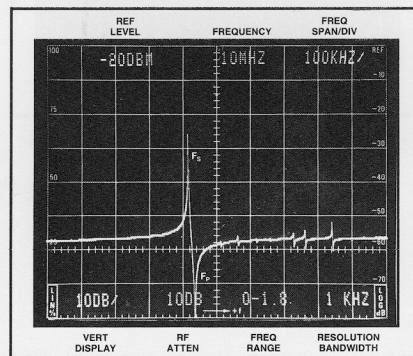

Figure 23. Crystal response to SA/TG system.

**Amplifier**

In Fig. 24, an amplifier is being tested. The input is at -40 dBm and the output is at -10 dBm; thus, a gain of 30 dB is realized. The 3 dB roll-off is in excess of 1100 MHz. The flatness up to 1100 MHz is less than 3 dB peak-to-peak. Further tests might include increasing the level of the input signal in 1 dB steps and

monitoring the output level for 1 dB increases to determine the 1 dB compression point (approaching saturation where output does not follow input with linear changes).

For more information on the subject of SA/TG measurements, see Tektronix, Inc. Application Note 26W-5121, "THE TRACKING GENERATOR/SPECTRUM ANALYZER SYSTEM."

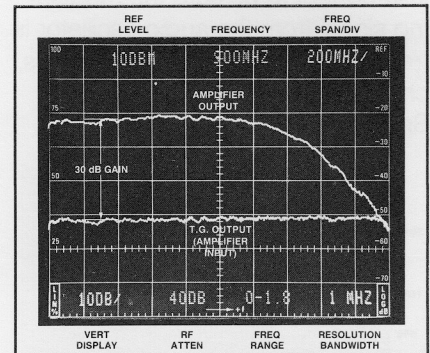

Figure 24. Amplifier response to SA/TG system.

**Pulsed RF (Radar)**

Pulsed waveforms when viewed in the time domain will appear as in Fig. 25. Different types of modulators will generate different types of pulses, but the commonality is a carrier that is turned on for a period of time, then off for a specified period. The period of time the pulse is on will be referred to as ( $t_{pw}$ ) and the pulse repetition rate will be  $f_r$ .

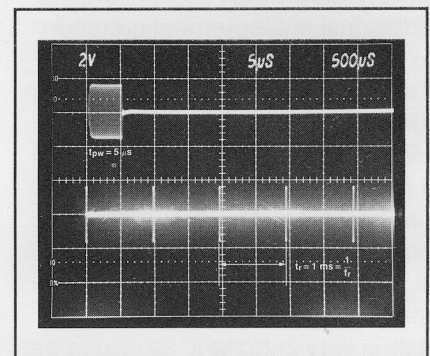

Figure 25. Time domain display of pulse waveform.

The same pulse waveform when displayed in the frequency domain would appear as shown in Fig. 26. Note that the pulse width ( $t_{pw}$ ) and

the repetition rate ( $f_r$ ) can be determined from the spectral display.

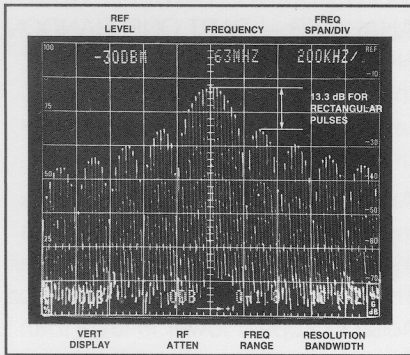

Figure 26. Frequency domain display of pulse waveform.

$$t_r = \frac{\text{sweep time/div}}{\# \text{ pulses/div}} = \frac{10 \text{ ms}}{10} = 1 \text{ ms}$$

$$t_{pw} = \frac{1}{\text{lobe width}} = \frac{1}{200 \text{ kHz}} = 5 \mu\text{s}$$

In the introduction, we learned that all waveforms can be described as a combination of various sinusoidal waveforms of differing amplitudes. The pulses in Fig. 25 are likewise composed of an infinite number of discrete sinusoidal frequencies of differing amplitudes. Since there are an infinite number of signals, we are primarily interested in the envelope of the amplitude of the signals. In our example, this is described by a

$$\frac{\sin x}{x}$$

display shown in Fig. 27. We can see that the amplitudes in Fig. 26 lie within the area described by Fig. 27. The big question is "Why do we see discrete signals in Fig. 26 if the waveform is composed of an infinite series of frequencies?"

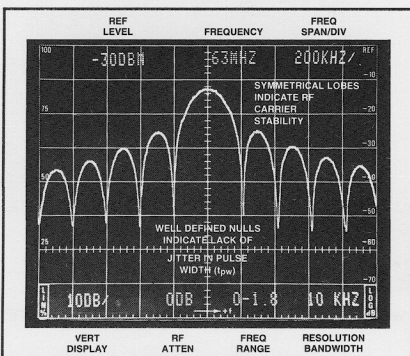

Figure 27. Envelope of pulsed signal

$$\left( \frac{\sin x}{x} \text{ envelope} \right)$$

The answer lies in the fact that swept frequency analyzers only analyze a specific frequency at a specific time as the beam traces across the screen. Each time a pulse is generated, the analyzer will analyze the amplitude of the frequency component at the frequency being analyzed at that instant. If the pulse repetition period ( $t_r$ ) of the pulse was 1 ms and the analyzer was sweeping through the frequency spectrum at 1 ms/div, we would see one spectral line/div. If we slowed the sweep speed to 100 ms/div, we would obtain 100 spectral lines/div, which would clearly show the envelope display of Fig. 27. We need to remember that although we are varying the sweep speed, we are not changing the span of frequencies being analyzed, just the rate at which we are analyzing them. To compute the repetition rate from Fig. 26, determine the number of divisions/spectral line and multiply by the sweep speed/division.

To display an optimum waveform of pulsed RF, the Resolution Bandwidth (RBW) should be selected narrow enough to display each spectral line. As the RBW is narrowed, the amount of energy from the pulse reaching the detector within the analyzer is reduced and the display will indicate a lower level signal than is actually present. The optimum Resolution Bandwidth (RBW) is approximately  $0.1/\text{pulse width } (t_{pw})$  or  $t_{pw} \times \text{RBW}$  equal-to-or-less-than 0.1.

Figure 28 shows the optimum RBW as a function of pulse width, and Fig. 29 shows the approximate sensitivity loss or signal amplitude loss as a function of the product of  $t_{pw} \times \text{RBW}$  (pulsewidth  $\times$  Resolution Bandwidth). Note that the type of Resolution Bandwidth Filter in the analyzer will vary the amount of loss between Pulsed RF and a CW signal of equal amplitude. 490 Series filters are of the rectangular response. Since there is a signal loss through an analyzer due to RBW limitations, it is important to remember that the front end of the

analyzer is being driven harder than the signals on the screen indicate. Care should be taken not to overdrive the input mixer.

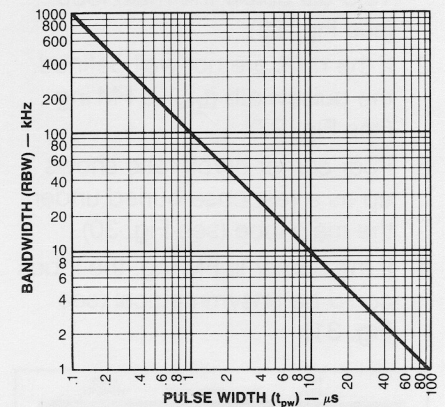

Figure 28. Resolution bandwidth setting for pulsed RF computed from  $[t_{pw}] \times \text{RBW} = 0.1$

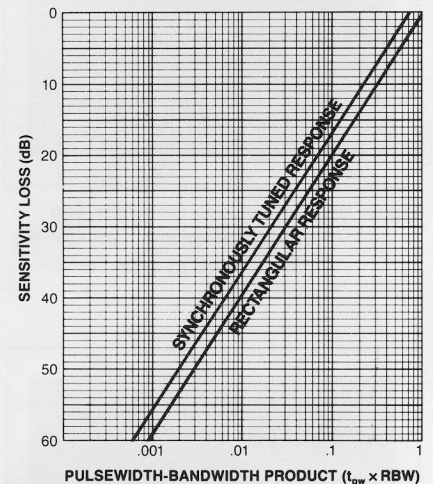

Figure 29. Sensitivity loss of pulsed signals vs CW.

For best results when analyzing pulsed RF, Digital Storage should be disabled until the optimum combination of sweep speed, span/div, RBW and Reference Level have been achieved. Once the desired waveform has been acquired, the storage can be activated with the Peak/Average cursor placed at the bottom of the screen. The Auto Sweep speed (time/div) and Auto RBW should not be used, as the algorithm used to compute the optimum setting is not valid for pulsed RF.

Typical observations of an RF spectrum would be the following:

1. For a rectangular pulse, the 1st sidelobe should be approximately 13.3 dB below the main lobe (see Fig. 26).
2. If the nulls are not well defined, the pulsewidth ( $t_{pw}$ ) is FM'ing (see Fig. 27).
3. Poor carrier on/off ratio shows up as a response buried under the main lobe (see Fig. 30).
4. If the carrier is FM'ing, the lobes could be unsymmetrical (see Fig. 31).

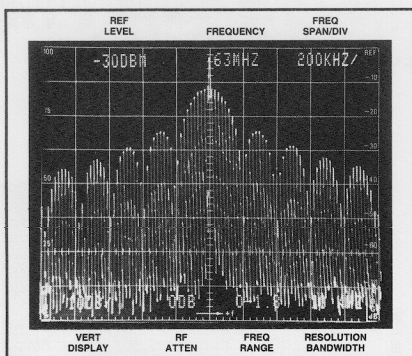

Figure 30. Note void in main lobe and pulse extension on top of main lobe caused by poor carrier on/off ratio.

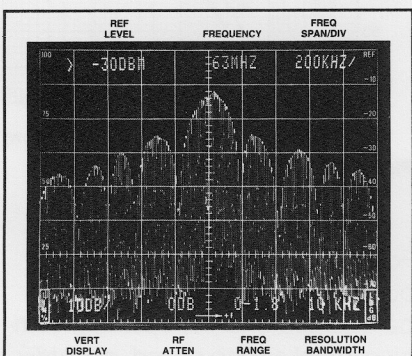

Figure 31. FM'ing carrier.

#### WARNING

Radar applications require relatively large amounts of power for proper operation. Signal access points on radar systems often have large signal levels that can be lethal to both people and Spectrum Analyzers. The input circuitry of Spectrum Analyzers is fragile. Use caution and plenty of external attenuators when observing unknown signals.

For further information on this subject, see Tektronix, Inc. Application Notes AX-4217, "PULSED RF SPECTRUM ANALYSIS" and AX-3259, "NOISE MEASUREMENTS USING THE SPECTRUM ANALYZER — PART TWO; IMPULSE NOISE."

### Noise Measurements

Noise measurements are often made as carrier-to-noise (C/N) measurements, oscillator spectral purity, white noise level, etc. The noise referred to is the level of the baseline signal or "grass" of a spectrum display. The unit of measure when dealing with random noise is usually dBm/Hz or Watts/Hz. The noise bandwidth must always be specified, because each decade of change in noise bandwidth will vary the measurement by 10 dB. Random Noise implies the noise is being analyzed through an idealized square-shaped filter. Since most filters are not of the idealized square shape, a correction factor may have to be generated to convert from the Spectrum Analyzer's Resolution Bandwidth (RBW) to the effective Noise Bandwidth of each filter. This correction is ex-

plained in Tektronix, Inc. Application Note AX-3260 "NOISE MEASUREMENTS USING THE SPECTRUM ANALYZER — PART ONE: RANDOM NOISE." If this correction is not made for the RBW used, errors of up to 2 dB can occur in the measurement.

Another source of error when making noise measurements occurs in the detector and logarithmic circuitry. These two errors cause the measured noise to appear lower in level than the actual noise by the following factors:

LIN display mode: 1.13 dB  
LOG display mode: 2.5 dB

An additional source of error involves dealing with very low level signals or in this case, system noise located close to the noise floor of the analyzer. To test for the analyzer's noise floor, disconnect the input and note the amplitude of the noise. When a signal or system noise is located within 10 dB of the analyzer noise floor, the amplitude of the measured signal or system noise will be indicated as being higher than it really is by a factor as determined in Fig. 32.

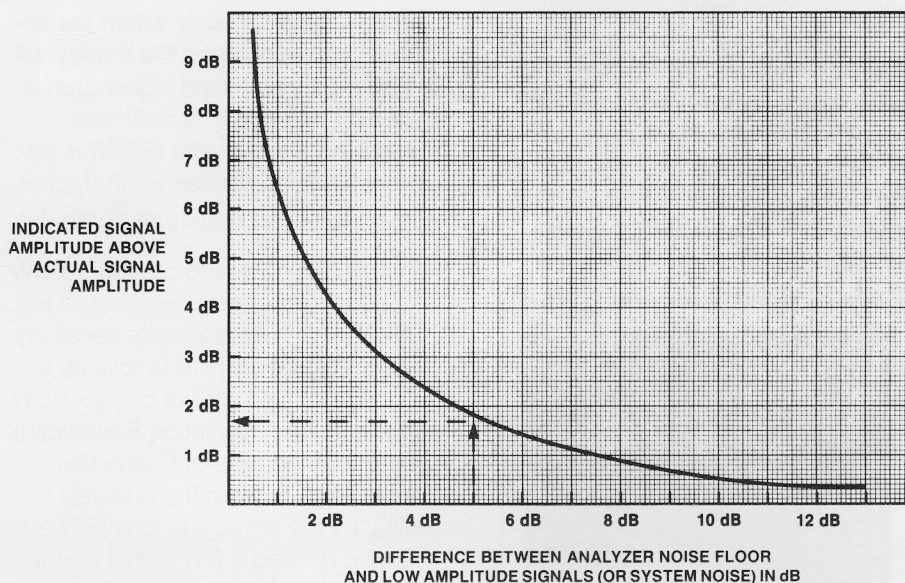

Figure 32. Amplitude correction for signals located within 10 dB (low level signals) of analyzer noise floor.



In our example of Fig. 33, the difference of analyzer noise floor to system noise floor is 5 dB. From Fig. 32, a correction factor of 1.7 dB must be subtracted from the indicated system noise amplitude to obtain the true noise level. (Remember that two signals of the same amplitude will indicate 3 dB more power than the amplitude of either of the signals. Thus, a signal measured 3 dB above the noise is actually at the same amplitude as the noise.)

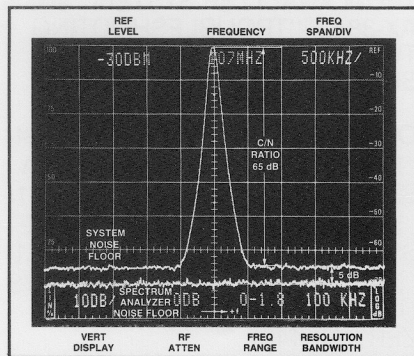

Figure 33. Carrier-to-noise ratio measurement including correction for low amplitude system noise.

A system will quite often have a noise specification of a noise bandwidth in other than a common Spectrum Analyzer RBW. To get from one bandwidth to another bandwidth, the following formula can be used.

$$\begin{aligned} \text{C/N at Specified Bandwidth (dB)} &= \text{C/N at Measured Bandwidth (dB)} \\ &- 10 \log \frac{\text{Specified Bandwidth (Hz)}}{\text{Measured Bandwidth (Hz)}} \end{aligned}$$

Using Fig. 33 as an example, we measured the carrier-to-noise ratio of a system as being 65 dB in a 100 kHz RBW. The system specification requires the result to be a 4 MHz noise bandwidth.

$$\begin{aligned} \text{C/N at 4 MHz} &= 65 \text{ dB at 100 kHz} \\ &- 10 \log \frac{4 \text{ MHz}}{100 \text{ kHz}} \\ &= 65 \text{ dB} - 16 \text{ dB} = 49 \text{ dB at 4 MHz} \\ &\text{RBW} \end{aligned}$$

The actual C/N at 4 MHz Noise Bandwidth is then determined by accounting for the analyzer's log error

and RBW/Noise Bandwidth correction factor and signal noise floor/analyzer noise floor correction factor. Each analyzer's RBW/Noise bandwidth correction factor must be compiled per the previously mentioned Tektronix, Inc. Application Note AX-3260. Let us assume a 1 dB error.

C/N at 4 MHz noise bandwidth = C/N at 4 MHz RBW + signal noise floor/analyzer floor correction - RBW/noise bandwidth correction factor - Log Error

For our example, then  
C/N at 4 MHz noise bandwidth = 49 dB at 4 MHz RBW + 1.7 dB - 1 dB RBW/noise bandwidth - 2.5 dB (C/N of example = 47.2 dB at 4 MHz noise bandwidth)

For more information on the subject of Noise, see Tektronix, Inc. Application Notes AX-3260 "NOISE MEASUREMENTS USING THE SPECTRUM ANALYZER — PART ONE: RANDOM NOISE", AX-3259, "NOISE MEASUREMENTS USING THE SPECTRUM ANALYZER — PART TWO: IMPULSE NOISE", and 26W-4889, "NO LOOSE ENDS — REVISED: THE TEKTRONIX PROOF OF PERFORMANCE PROGRAM FOR CATV."

## Antenna Sweeps (SWR)

Antenna sweeps are performed on antenna systems to determine if the antenna is "tuned" for the frequency at which it will transmit or receive. An improperly tuned transmitting antenna can cause much of the energy created by a transmitter to be reflected back into the transmitter causing Intermodulation Distortion thus causing a loss of effective power being radiated. A properly tuned antenna will have its characteristic impedance at the frequency of intended use. The measurement of a system standing wave ratio (SWR) can be made using a Spectrum Analyzer, Return Loss Bridge, and a Tracking Generator or Sweeper capable of operating at the frequency of antenna operation. From the SWR, you can determine the system impedance at any frequency over which the SWR was measured.

SWR measurements are made using the mentioned equipment and connected as shown in Fig. 34. A Return Loss Bridge designed for the characteristic impedance of the antenna must be used.

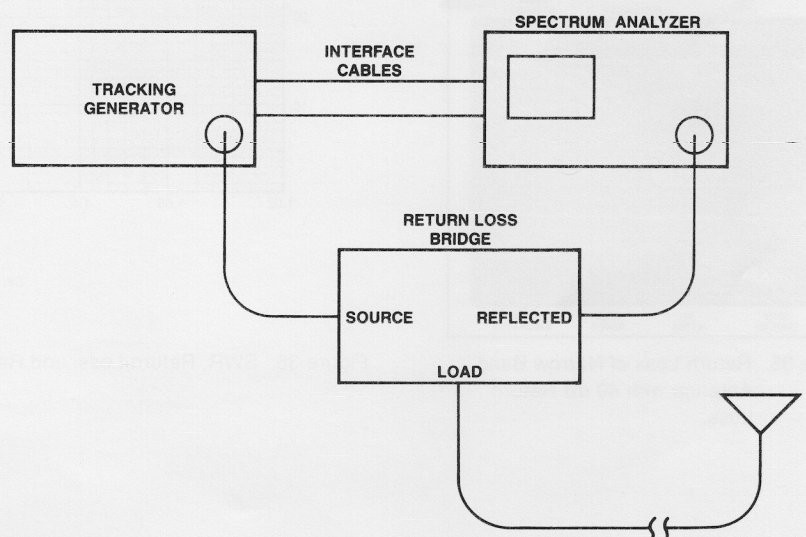

Figure 34. SWR test setup.

The system operates by the signal source (Tracking Generator in this case) launching a signal at a specific frequency to the Return Loss Bridge (Bridge). The Bridge routes the signal to the antenna or system under test, but not to the analyzer. If the termination at the end of the line looks like the system characteristic impedance, all the energy is absorbed and nothing is reflected. If the termination is not at the characteristic impedance, a portion of the energy will be reflected back to the Bridge where it will be routed to the Spectrum Analyzer and displayed on screen. As the sweeper or tracking generator sweeps across the frequency band selected, the analyzer will plot a graph of Return Level or Return Loss (in dB) vs. frequency.

System calibration requires terminating the antenna end of the cable with an "open" or "short" to reflect all the energy back, and adjusting the analyzer with a display at the top of the screen. Then, by terminating the antenna end of the cable into the characteristic impedance, the operator can determine the display level representing the characteristic impedance. Fig. 35 shows a typical display of an antenna trimmed or tuned for operation at 135 MHz.

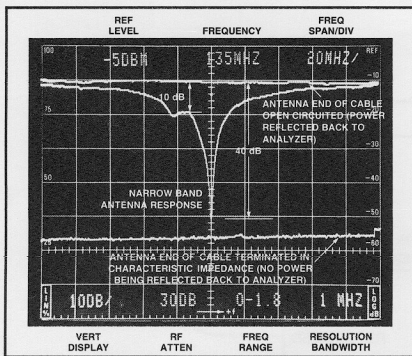

Figure 35. Return Loss of Narrow Band Antenna with 40 dB Return Loss.

Figure 35 demonstrates a narrow band antenna being swept from 35 MHz to 235 MHz. The antenna is showing a 40 dB "Return Loss" at 135 MHz. From Fig. 36 we can determine the antenna's SWR as being 1.02:1. At 110 MHz, the SWR=2.0:1.

One of the limitations and problems associated with the setup of Fig. 34 is: Most signal sources are only capable of generating between 1 mW and 1 W of power. Therefore, the analyzer will be set with very little RF attenuation. If another nearby transmitter broadcasts during the period the test is being conducted, excessive power could be received by the antenna being tested and damage the Spectrum Analyzer. If an amplifier is available to place between the tracking generator and the Bridge to boost the power (amplifier system should be checked for flatness), then external attenuators can be placed between the Bridge and Spectrum Analyzer to reduce the signal and protect the analyzer.

The Return Loss Bridge specification should be checked for power handling capability.

**WARNING**

**Extreme caution must be practiced when operating an analyzer near high power RF equipment. Excessive power applied to the input will damage a Spectrum Analyzer.**

For more information on SWR Measurements, see Tektronix, Inc. Application Notes 26W-5121, "THE TRACKING GENERATOR/SPECTRUM ANALYZER SYSTEM" and AX-3842, "TROUBLESHOOTING TWO-WAY RADIOS WITH THE SPECTRUM ANALYZER."

**Other Application Notes of interest:**

- "EMI MEASUREMENTS USING A SPECTRUM ANALYZER" 26W-4971.
- "EMI APPLICATIONS USING THE SPECTRUM ANALYZER" AX-3406-1.
- "DIGITAL RADIO MEASUREMENTS USING THE SPECTRUM ANALYZER" AX-4457.
- "FM BROADCAST MEASUREMENTS USING THE SPECTRUM ANALYZER" 26AX-3582-3.

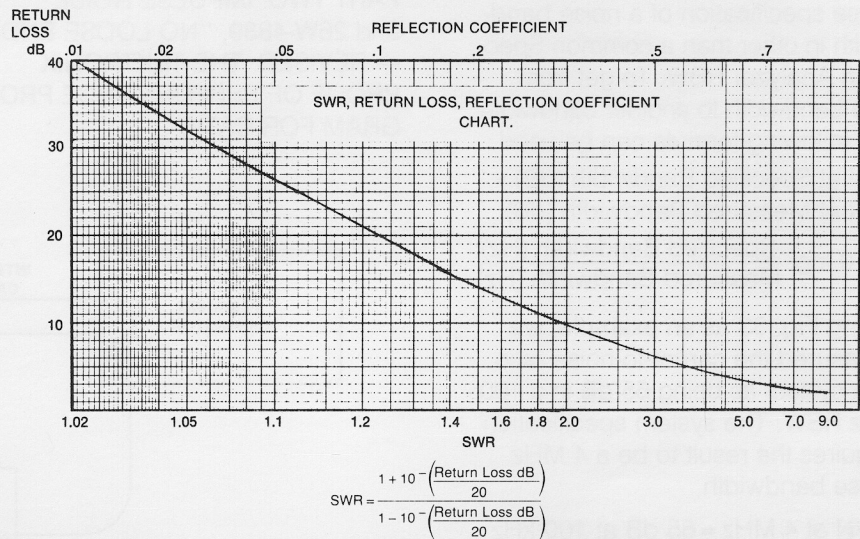

Figure 36. SWR, Return Loss, and Reflection Coefficient Chart.

## Glossary

**AMPLITUDE MODULATION (AM):** The process, or the result of the process, whereby the amplitude of one electrical quantity (carrier frequency) is varied in accordance with some selected characteristic of a second quantity (modulating frequency).

**B-SAVE-A:** A mode of display whereby a waveform which is stored in a digital memory is subtracted from a waveform stored in a second memory with the result being displayed on screen.

**BASILINE CLIPPER:** A means of blanking the signal at the baseline portion of the display.

**CALIBRATOR:** A signal generator whose output is used for purposes of calibration, normally either amplitude or frequency or both.

**CARRIER:** The wave (frequency) to which modulation is applied.

**CENTER FREQUENCY:** That frequency which corresponds to the center of a frequency span, (Hz).

**COMB GENERATOR:** A signal source which produces a frequency and multiple harmonics of the fundamental frequency. Signals are equally spaced at the frequency of the fundamental.

**DEGAUSS:** To neutralize the residual magnetic polarity of an electronic device by electric means.

**DELTA F:** A difference in frequency. A mode of operation of an analyzer where the difference in frequency of two signals can be read out directly.

**DIGITAL STORAGE:** A means of storing the display in modern spectrum analyzers. Allows for flicker-free displays that may be held in memory. Also includes capabilities such as digital averaging and storing maximum signal excursions.

**DIPLEXER:** A device capable of simultaneously directing one signal out and receiving another signal on the same port. The received signal is then routed out in a separate port.

**DISTORTION:** An undesired change in waveform caused by signal processing in a non-linear device or system.

**DYNAMIC RANGE:** The maximum ratio of two signals simultaneously present at the input which can be measured to a specified accuracy.

**EXTERNAL MIXER:** A device used to mix the 1st local oscillator of a spectrum analyzer with RF frequencies. This mixer is external to the analyzer. Typically the mixing is occurring within a waveguide.

**FILTER:** A circuit for separating signals on the basis of their frequency.

**1ST LO OUTPUT:** A port on a spectrum analyzer where the 1st local oscillator frequency is made available for use outside the analyzer.

**FLATNESS:** The unwanted variation of the displayed amplitude over a specified frequency span, expressed in decibels.

**FREQUENCY BAND:** A range of frequencies that can be covered without switching (in units of Hz).

**FREQUENCY MODULATION (FM):** The process, or the result of the process, whereby the frequency of one electrical quantity (carrier frequency) is varied in accordance with some selected characteristic of a second quantity (modulating frequency).

**FREQUENCY RANGE:** That range of frequencies over which the instrument performance is specified (Hz to Hz). May refer to the range of frequencies available in a particular band.

**FREQUENCY SPAN:** The magnitude of the frequency band displayed, expressed in hertz or hertz per division.

**HARMONIC:** A sinusoidal component of a periodic wave or quantity having a frequency that is an integral multiple of the fundamental frequency.

**HARMONIC (N) MIXING:** The product of one signal combining with harmonics of a second signal. This method of mixing is used in spectrum analyzers to obtain coverage in higher frequency bands than would otherwise be possible with fundamental conversions.

**IDENTIFY CONTROL:** A function which enables the user of an analyzer to determine if a signal being displayed represents a signal at the frequency indicated or is an undesired mixing product of the first mixer.

**IF (Intermediate Frequency):** A frequency at which the input signal is shifted internally for processing.

**INTERCEPT POINT:** The theoretical points at which the fundamental (driving) signals and the distortion products have equal amplitudes.

**LINEAR DISPLAY:** A display in which the vertical scale divisions are a linear function of the input signal voltage.

**LOG DISPLAY:** A display in which the vertical scale divisions are a logarithmic function of the input signal power.

**MAX HOLD:** A mode of acquisition for a digital storage system where the maximum amplitude achieved at every frequency being analyzed is retained and continuously displayed for successive sweeps.

**MAX SPAN:** A mode of operation in which the spectrum analyzer scans an entire frequency band.

**MAXIMUM INPUT LEVEL:** Maximum amount of power capable of being handled by input circuitry without damage.

**NOISE:** Unwanted disturbances superimposed upon a useful signal that tend to obscure its information content.

**NOISE SIDEBAND:** Undesired response caused by noise internal to the spectrum analyzer appearing on the display around a desired response.

**OPTIMUM INPUT LEVEL:** Design parameter of first mixer which allows for maximum dynamic range (largest carrier to noise ratio) and minimum distortion.

**OSCILLOSCOPE:** An instrument primarily for making visible the instantaneous value of one or more rapidly varying electrical quantities as a function of time or of another electrical or mechanical quantity.

**PEAK/AVERAGE CURSOR:** A manually controllable function which allows the user an option to the type of signal processing of data prior to storage in a digital storage system.

**PEAKING:** The adjusting of a circuit for maximum amplitude of a signal by aligning internal filters.

**PHASE LOCK:** The control of an oscillator or periodic generator so as to operate at a constant phase angle relative to a stable reference signal source. Primary use in analyzers is for frequency stability of oscillators.

**PRESELECTOR:** A device placed ahead of a frequency converter or other device, that passes signals of desired frequencies and reduces others.

**PRODUCTS:** The resultant frequencies produced through mixing of two or more signals.

**PULSE STRETCHER:** A pulse shaper that produces an output pulse whose duration is greater than that of the input pulse and whose amplitude is proportional to that of the peak amplitude of the input pulse.

**REFERENCE LEVEL:** A selected level or amplitude associated with the top graticule of the CRT. Any signal displayed whose amplitude reaches the top graticule is said to have an amplitude equal to the Reference Level quantity.

**REFRESH RATE:** The rate or frequency at which a swept CRT display is refreshed (updated). This rate is typically greater than 50 Hz to avoid flicker.

**RESOLUTION BANDWIDTH (RBW):** The bandwidth of the most selective amplifier/filter.

**RF ATTENUATOR:** A device which reduces the amplitude of an input signal to a level required by the input mixer. The term RF implies linear operation into the high frequencies.

**RF INPUT:** The input connector or circuitry directly behind the input connector.

**RING:** An overshooting condition where the signal will exceed its steady state condition momentarily before stabilizing after a perturbation.

**SAVE A:** A mode of display whereby a waveform which is stored in digital memory is not modified by succeeding sweeps (i.e., the waveform is frozen).

**2ND LO OUTPUT:** A port on a spectrum analyzer where the 2nd local oscillator frequency is made available for use outside the analyzer.

**SENSITIVITY:** Measure of a spectrum analyzer's ability to display minimum level signals, at a given IF bandwidth, display mode, and any other influencing factors and expressed in decibels (e.g., -120 dBm).

**SHAPE FACTOR (Skirt selectivity):** A measure of the asymptotic shape of the resolution bandwidth response curve of a spectrum analyzer. The ratio between the frequency difference between two widely spaced points on the response curve, such as the 6 decibels and 60 decibels down points.

**SINGLE SWEEP:** Operating mode for a triggered sweep instrument in which the sweep must be reset for each operation, thus preventing unwanted displays.

**SPECTRUM ANALYZER:** A device which is generally used to display the power distribution of an incoming signal as a function of frequency.

**SPURIOUS RESPONSE:** A characteristic of a spectrum analyzer wherein the displayed frequency does not conform to the input frequency.

**STABILITY:** The property of retaining defined electrical characteristics for a prescribed time and environment (such as frequency stability or amplitude stability).

**SWR (Standing Wave Ratio):** The ratio of the maximum amplitude to the minimum amplitude of a signal in a system caused by reflections at the termination of the system. The impedance mismatch causes reflections of the forward signal to combine with the forward signal both in and out of phase to produce the peaks and nulls.

**TIME/DIV:** The sweep rate control which defines the rate at which the analyzer sweeps through a defined frequency spectrum.

**TRACKING GENERATOR:** Signal source whose output frequency tracks in synchronism with the input frequency of a receiver, such as the spectrum analyzer.

**TRIGGER:** A pulse used to initiate a triggered sweep or delay ramp.

**ULTIMATE:** The ability of a filter to reject or suppress a frequency other than which it was designed to pass.

**VERTICAL DISPLAY FACTOR:** The Y-axis scale factor for display on a CRT.

**VIDEO FILTER:** A post detection low pass filter.

**VIEW A, VIEW B:** Controls which allow two memories to be enabled for viewing or disabled independently of each other.

**VSWR (Voltage Standing Wave Ratio):** The ratio of the magnitude of the transverse electric field in a plane of maximum strength to the magnitude at the equivalent point in an adjacent plane of minimum field strength.

**ZERO SPAN:** A mode of operation in which the frequency span is reduced to zero.

Radar pulse width, pulse shape, repetition rate and carrier frequency monitored on one display.

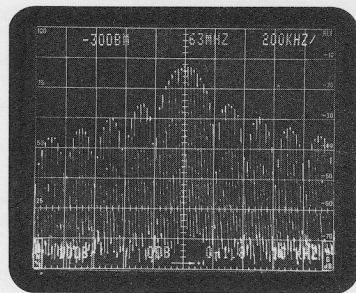

**Performance  
worth the  
name**

**Tektronix**<sup>®</sup>  
COMMITTED TO EXCELLENCE

**For further information, contact:**

**U.S.A., Asia, Australia, Central  
& South America, Japan**

Tektronix, Inc.  
P.O. Box 1700  
Beaverton, Oregon 97075  
For additional literature, or the  
address and phone number of the  
Tektronix Sales Office nearest  
you, contact:  
Phone: 800/547-1512  
Oregon only 800/452-1877  
TWX: 910-467-8708  
TLX: 15-1754  
Cable: TEKTRONIX

**Europe, Africa,  
Middle East**

Tektronix Europe B.V.  
European Headquarters  
Postbox 827  
1180 AV Amstelveen  
The Netherlands  
Phone: (20) 471146  
Telex: 18312 - 18328

**Canada**

Tektronix Canada Inc.  
P.O. Box 6500  
Barrie, Ontario L4M 4V3  
Phone: 705/737-2700

**Tektronix sales and service  
offices around the world:**

Albania, Algeria, Angola,  
Argentina, Australia, Austria,  
Bangladesh, Belgium, Bolivia,  
Brazil, Canada, Peoples Republic  
of China, Chile, Colombia, Costa  
Rica, Czechoslovakia, Denmark,  
East Africa, Ecuador, Egypt,  
Federal Republic of Germany,  
Finland, France, Greece, Hong  
Kong, Hungary, Iceland, India,  
Indonesia, Ireland, Israel, Italy,  
Ivory Coast, Japan, Jordan,  
Korea, Kuwait, Lebanon,  
Malaysia, Mexico, Morocco, The  
Netherlands, New Zealand,  
Nigeria, Norway, Pakistan,  
Panama, Peru, Philippines,  
Poland, Portugal, Qatar, Republic  
of South Africa, Romania, Saudi  
Arabia, Singapore, Spain, Sri  
Lanka, Sudan, Sweden,  
Switzerland, Syria, Taiwan,  
Thailand, Turkey, Tunisia, United  
Kingdom, Uruguay, USSR,  
Venezuela, Yugoslavia, Zambia,  
Zimbabwe.

Copyright © 1983, Tektronix, Inc. All  
rights reserved. Printed in U.S.A.  
Tektronix products are covered by U.S.  
and foreign patents, issued and  
pending. Information in this publication  
supersedes that in all previously  
published material. Specification and  
price change privileges reserved.  
TEKTRONIX, TEK, SCOPE-MOBILE,  
TELEQUIPMENT, and  are  
registered trademarks. For further  
information, contact: Tektronix, Inc.,  
P.O. Box 500, Beaverton, OR 97077.  
Phone: (503) 627-7111; TWX 910-467-  
8708; TLX: 15-1754; Cable:  
TEKTRONIX. Subsidiaries and  
distributors worldwide.